

## Features

- **Frequency Range**  
1 GHz to 18 GHz (useable from 700 MHz)
- **Transmit & Receive Capabilities**  
emissions/immunity applications
- **Individual Calibration Included**  
per ANSI C63.5 or SAE ARP958 with NIST traceability
- **Three-year Standard Warranty**

## Description

The AH-118 is a broadband, linearly polarized Double Ridge Waveguide Horn Antenna, operating over the frequency range of 700 MHz to 18 GHz; and with excellent efficiency between 1 GHz and 18 GHz. It can be used as a receiving or transmitting antenna.

## Construction

The AH-118 is designed to be extremely durable, making it an ideal choice for daily use in laboratory environments, both indoors and outdoors, and even under continuous exposure to extreme weather conditions. The antenna is constructed using a heavy gauge, high grade, aluminum with a corrosion resistant coating. It is fitted with a high quality, precision N-type coaxial connector.

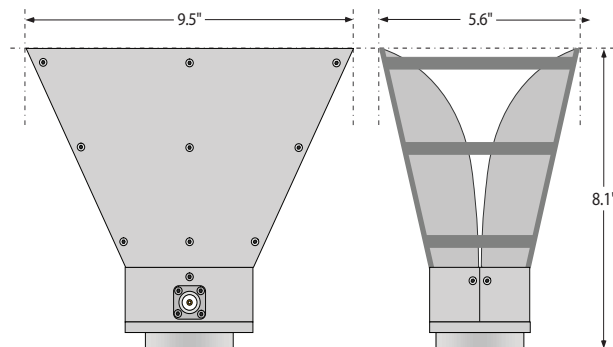

## Calibration

Each antenna is individually calibrated per ANSI C63.5 or SAE ARP958 with NIST traceability. The calibration data and certificate is provided. Recognized ISO 17025 accredited calibration is also available upon request.

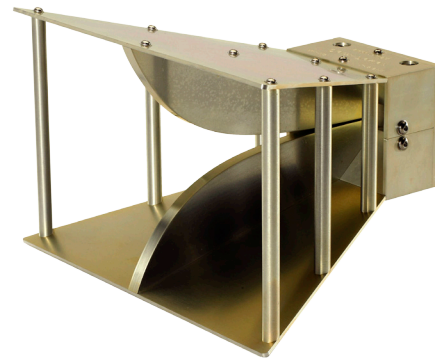

## Application

The AH-118 Double Ridge Horn Antenna is suitable for use as an EMI test antenna for qualification-level regulatory compliance measurements (FCC, CE, MIL-STD-461, RTCA DO-160, FDA, SAE, etc.).

The AH-118 is equally suitable for use transmitting antenna for establishing radiated RF fields for product immunity tests, and is capable of handling power levels up to 300 Watts.

Another common application for the AH-118 is to use it as a “substitution antenna” for determining the Effective Radiated Power (ERP) and/or Effective Isotropic Radiated Power (EIRP) of intentional radiators (RF transmitters). These tests are typically applicable for products operating within licensed frequency bands requiring FCC/TCB Certification, and also for European acceptance tests per ETSI standards for radio equipment.

Notwithstanding the above applications, the AH-118 can also be used for site comparisons, shielding effectiveness tests of enclosures, field monitoring, site surveys and other general purposes.

## Mounting

The AH-118 can easily be secured to any tripod or mast via its standard 1/4-inch x 20 mounting hole located on the back of the antenna. For installations without a horizontal mounting bolt arrangement, a right-angle mounting bracket is supplied, which mounts to the rear of the horn so that the orientation of the 1/4-inch x 20 mounting hole is vertical.

### Specifications

Product Name	<b>Double Ridge Horn Antenna</b>
Frequency Range	<b>1 GHz to 18 GHz</b> (useable from 700 MHz)
Polarization	<b>Linear</b>
Nominal Impedance	<b>50Ω</b>
Power Handling	<b>300 Watts</b> (continuous)
Connector	<b>Precision N-type</b> (female)
Antenna Factor	<b>26.4 to 47.4</b> (average: <b>38.9</b> ) [dB(m <sup>-1</sup> )]
Isotropic Gain	<b>3.6 to 12.6</b> (average: <b>9.1</b> ) dBi
VSWR	<b>1.58 to 3.32</b> (average: <b>2.25</b> ):1
Return Loss	<b>5.4 to 12.9</b> (average: <b>8.8</b> ) dB
Radiated Field Strength	see graph below
Specifications	<b>FCC, CISPR, EN, ETSI, FAA, Mil-Std, SAE, etc.</b>
Dimensions (H x W x D)	<b>5.6" x 9.5" x 8.1"</b> [14.2 x 24.1 x 20.6 cm]
Weight	<b>3 lbs.</b> [1.4 kg]

All specifications are subject to change without notice.  
All values are typical, unless specified.

Accessories available  
from Com-Power:



PAM-118A Preamplifier



AT-812 Antenna Tripod

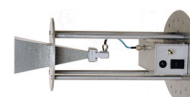

AHA-840 Active Horn Antenna

Also Available:

AB-900 Biconical Antenna

AHA-118 Active Horn Antenna

AL-100, ALC-100, ALP-100 Log Periodic Antennas

### Antenna Factors / Isotropic Gain

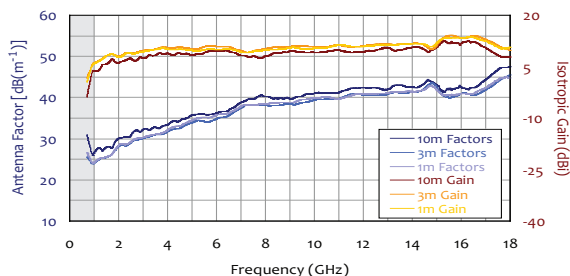

### -3 dB [Half-Power] Beamwidth

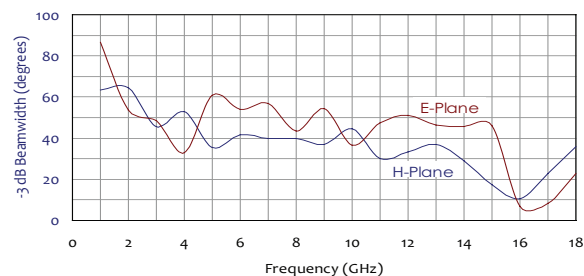

### Voltage Standing Wave Ratio (VSWR)

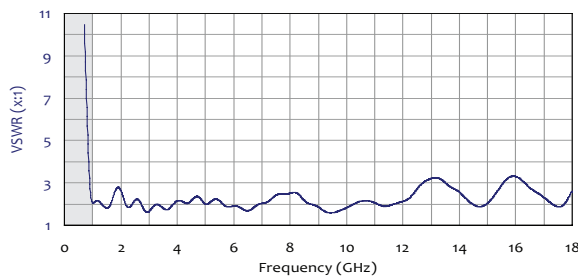

### Return Loss

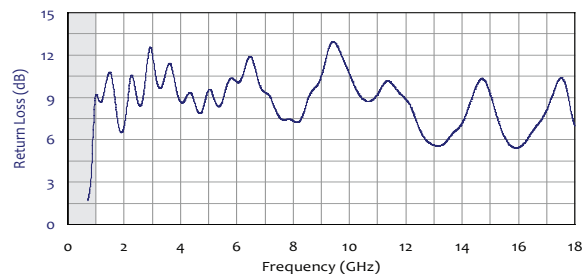

### Typical Field Strength with 300W Input Power

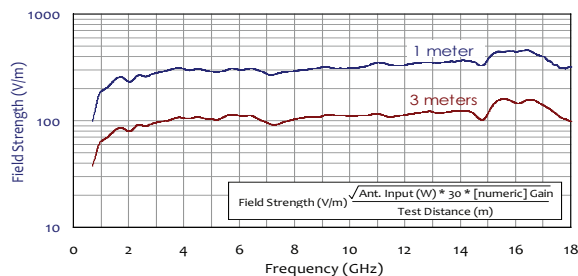

### Typical Forward Power Levels

